

ENERGIZING TALIESIN WEST™



**Celebrating Frank Lloyd Wright's Legacy of Innovation
and Arizona's Leadership in Sustainable Energy Deployment**



100 Years of AZ Sustainability



Taliesin West

- 20th Century
 - Frank Lloyd Wright's 1937 laboratory for organic design and home of the Frank Lloyd Wright School of Architecture.
- 21st Century
 - National historic landmark with 110,000 annual visitors.
 - Working to advance Frank Lloyd Wright's legacy of innovation.

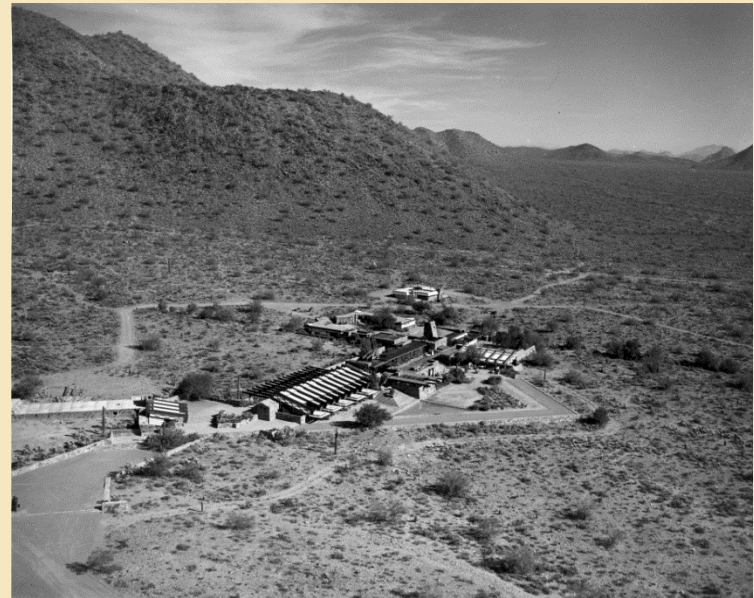

The Frank Lloyd Wright Foundation Archives (The Museum of Modern Art | Avery Architectural & Fine Arts Library, Columbia University, New York)

Opportunity For Innovation

- The Problem
 - Cost of operating energy systems approaching \$170,000.
 - Concern for doing the right thing environmentally.
- The Opportunity
 - Make energy efficiency a continuous improvement process.
 - Reduce energy use 50% through efficiency investments.
 - *After improving efficiency, add solar PV for a “big green zero.”*

The Energizing Mission

“During January, 2011, the energy assessment team was working in Frank Lloyd Wright’s 1937 office at Taliesin West.

At that moment, I realized that we were on a mission to energize Mr. Wright’s legacy of innovation . . . and also his beloved Taliesin West.”

Robert Roth, Ph.D.
CEO
Big Green Zero & Energy Actio



The Frank Lloyd Wright Foundation Archives (The Museum of Modern Art Avery Architectural & Fine Arts Library, Columbia University, New York)



Opportunity For Innovation

Mission of The Frank Lloyd Wright Foundation

- Preserve and steward Taliesin, Taliesin West, and the Taliesin Collections.
- Shape architecture and design at the highest level.
- Transform people's lives through the living experience of Frank Lloyd Wright's body of work.



Energizing Taliesin West Goals

1. Continuing Frank Lloyd Wright's legacy of innovation.
2. Reducing energy cost and carbon contributions.
 - Transforming wasted energy expense into restoration investment.
3. Achieving a net zero grid balance.
4. Providing sustainable energy education.
 - 110,000 annual visitors
 - 10,000 media articles (first few months)
5. Respecting the historic and architectural environment.
6. Attracting product, services and financial donations.



Legacy of Innovation

Frank Lloyd Wright dedicated his life and work to bringing designs of beauty and humanity to ordinary people.

His work was a continuous experiment to find better and less expensive methods for building structures and for utilizing them.

Energizing Taliesin West is dedicated to advancing this legacy into and beyond the 21st Century.

Sean Malone
Chief Executive Officer
The Frank Lloyd Wright Foundation



The Frank Lloyd Wright Foundation Archives (The Museum of Modern Art | Avery Architectural & Fine Arts Library, Columbia University, New York)



Program Development

January, 2011

- ❑ Big Green Zero completes *EnergyActio* assessment

March, 2011

- ❑ Big Green Zero proposes *Energizing Taliesin West™*

June, 2011

- ❑ Big Green Zero starts pursuing donor partners

August, 2011

- ❑ First Solar joins FLIW Foundation & Big Green Zero as a Founding Partner.
- ❑ First Solar & Power-One donate 250 kW AC PV system

March, 2012

- ❑ Studio Lux donates LED design services

May, 2012

- ❑ First Solar installation is completed



First Solar at a Glance



Over 7GW installed worldwide and over 3GW contracted pipeline



Cost competitive with conventional energy sources today



Partner of choice for leading utilities and global power buyers



Driving innovation across entire value chain and plant solution



Strongest financial stability & bankability in the industry



Founded in 1999 and publicly traded on Nasdaq (FSLR)



ENERGIZING
TALIESIN WEST



EnergyActio[™]

Community Engagement



College of the Desert community engagement in California, USA

- Donated solar equipment, training, and a curriculum

- Involving local communities where we manufacture or build projects
- Educating stakeholders on the benefits of PV solar power
 - Partnering with organizations on research and advocacy
 - Collaborating with local educational institutions on training programs
- Promoting best practices and standards in sustainability
- First Solar's *Global Charitable Giving Program*:
 - Supporting “green” education initiatives
 - Donating modules to provide clean energy and water
 - R&D of innovative and sustainable technologies

Innovation In Use of Natural Resources

PV Module Arrays

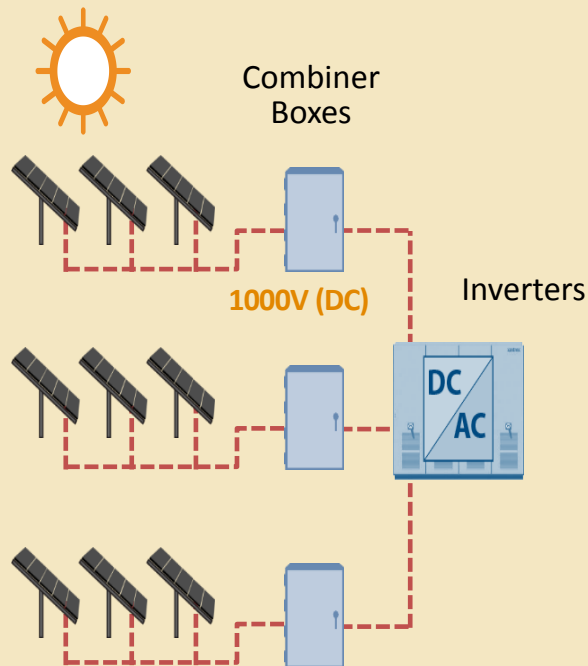

- 250 kW (AC) ground-mount PV system
- ~500 MWh per year
 - Power ~40 average Arizona homes
 - Displace ~300 metric tons CO₂e per year (~50 cars off the road)
 - Displace ~440,000 L of water consumption per year

PV Project Construction



Maintaining Historic Integrity

- Minimize impacts in the development, construction and decommissioning stages of PV power plants:
 - Site selection and biodiversity protection
 - Community engagement/stakeholder involvement
 - Minimal land use
 - Mitigating impacts: soil, noise, dust, visual/design
- Promote best practices within the solar industry

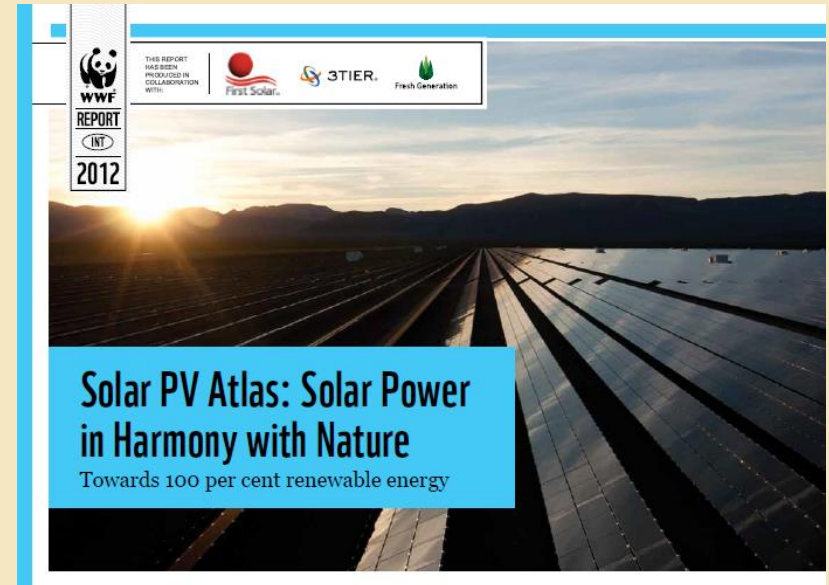

Educational Opportunity

- The Earth receives enough solar energy each hour to meet the world's annual energy needs.

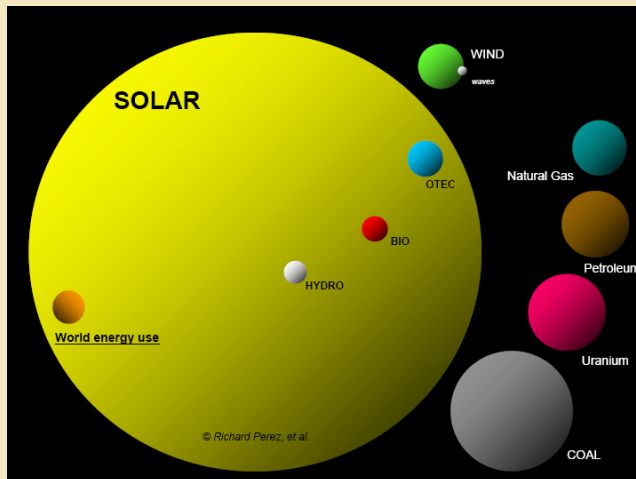

- No emissions, waste, or water use during operation
- In AZ, each kWh displaces:
 - 0.6 kg CO₂e,
 - 0.8 g NO_x, 0.4 g SO₂
 - 0.9 L H₂O
- Quiet
- Scalable
- Minimal maintenance
- Lifetime of 25+ years

Converting Sunlight Into Electricity

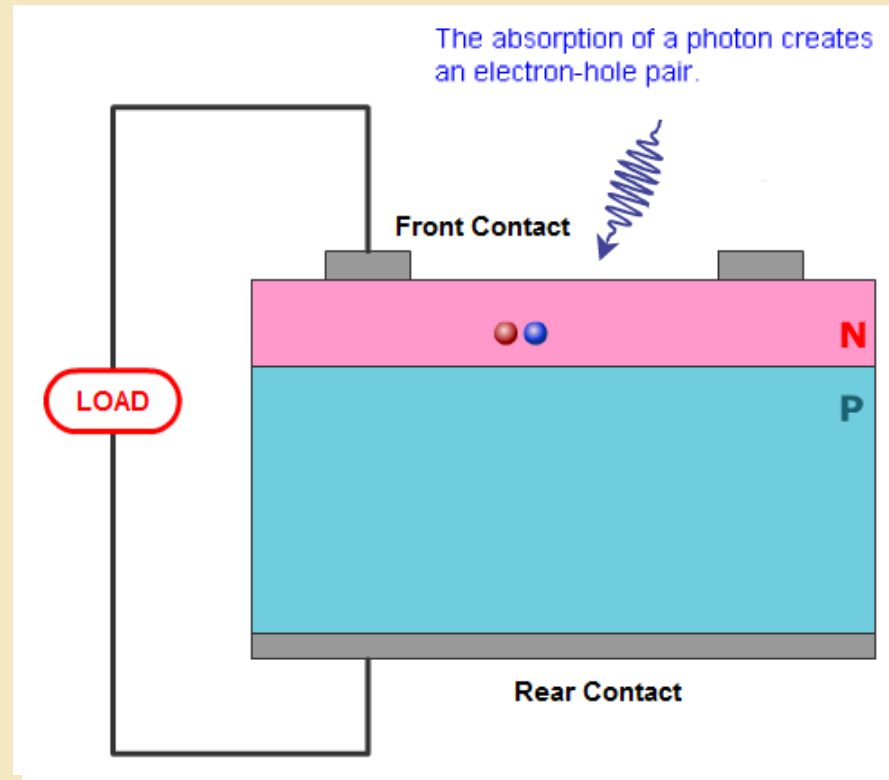

<http://www.pveducation.org/>

Thin Film Photovoltaics

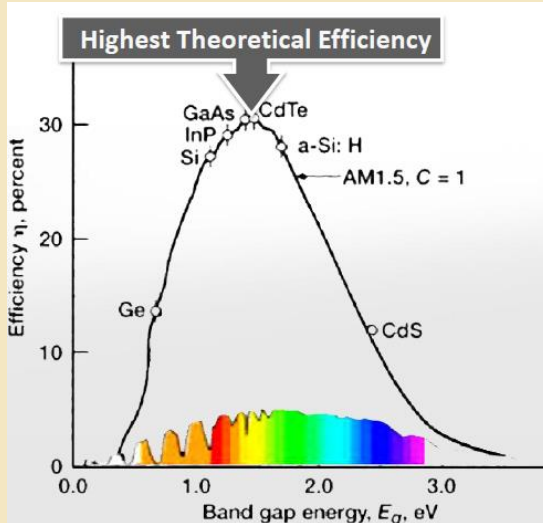

CdTe (~3 μm)

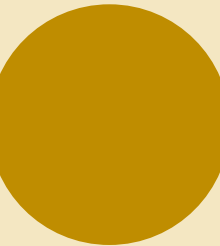

Human Hair (~100 μm)



Silicon Wafer (~180 μm)

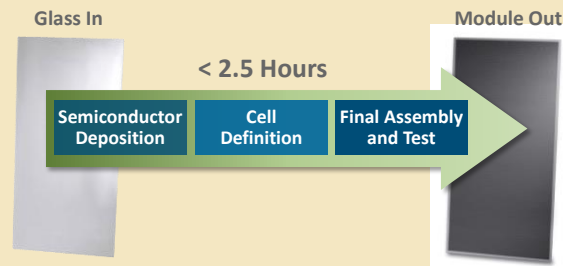

FRANK
LOYD
WRIGHT
ENERGIZING
TALIESIN WEST



EnergyActio™

Economic Benefits of Solar Projects

- **230 MW AVSR1 (California, USA)**
 - ~ 400 construction jobs over 3-4 years
 - Up to 20 ongoing monitoring and operations positions
 - Increased state and local tax revenues
 - Economic benefits to local businesses
 - Contributing to local education and nature preservation
- **In the U.S. (2012)**
 - First Solar spent more than \$1 billion annually on over 1,000 suppliers
 - Resulting in over 7,000 indirect jobs in U.S. companies

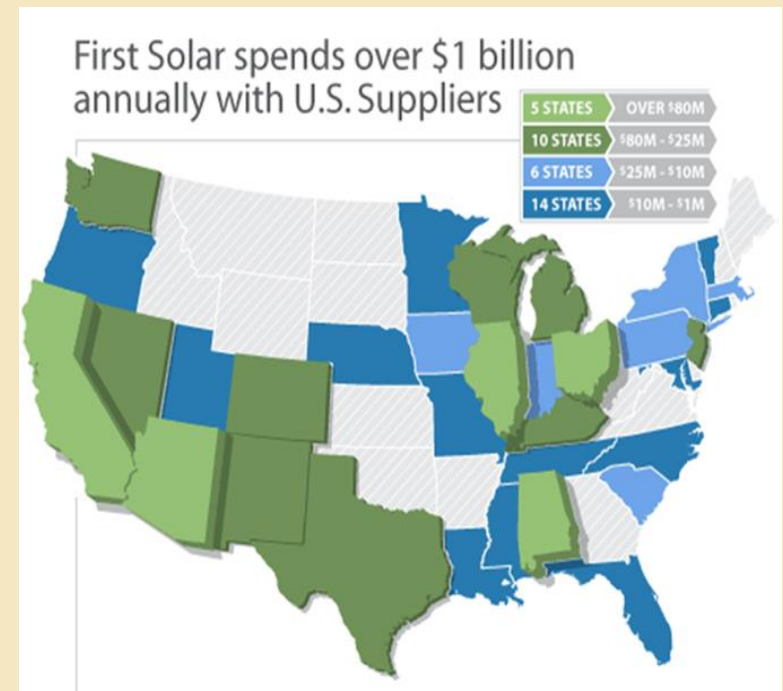

Energizing Work To-Date

- Completed *EnergyActio* assessment.
- Installed 250 kW A/C First Solar PV system.
- Installed a 250 kW Power-One inverter.
- Designed campus-wide LED retrofit.
- Modified propane gas system.
- Revitalized Cabaret theater with digital system.
- Explored preliminary designs for fabric daylight roofing.
- Made campus-wide electrical infrastructure improvements.

Energizing Results To-Date

- Value of donations:
\$1.7 mil.
- Annual LP gas savings:
\$45,000
- Reduction in grid energy use:
45%
- Reduction in electrical cost:
\$28,000 (35%)
- Media articles to-date:
+ 10,000
- Visitor exposures (annual):
+110,000



Lessons Learned

- Improving Energy is a continuous improvement process.
- Energy efficiency + Solar PV can = a big green zero.
- Visitors and media appreciate the “net zero” story.
- The ETW partnership has been deeply rewarding.
- Solar PV can be compatible with historic requirements.

Thank You Partners!

- The Frank Lloyd Wright Foundation
- First Solar, Inc.
 - Power-One, Inc.
 - Klondyke Construction, Inc
 - Rummel Construction, Inc.
 - Buesing Corporation
- Studio Lux, LLC
- HomeTech Europe, LLC
- Big Green Zero®
- EnergyActio™



ETW is Just Getting Started

Next Steps:

- LED lighting
- Under development:
 - Geothermal HVAC
 - Conventional HVAC
 - Energy monitoring and controls
 - Daylight fabric roofing
 - Water conservation

Big Green Zero and the Frank Lloyd Wright Foundation continue to seek best-of-breed sustainable technology partners.



Contacts

For Big Green Zero and EnergyActio

BobRoth@EnergyActio.com

For First Solar

Parikhit.Sinha@FIRSTSOLAR.COM



EnergyActio™